

THE POWER OF

REDARC®

Monocrystalline Fixed Solar Panel

MODELS

- SPRP1180
- SPRP1200

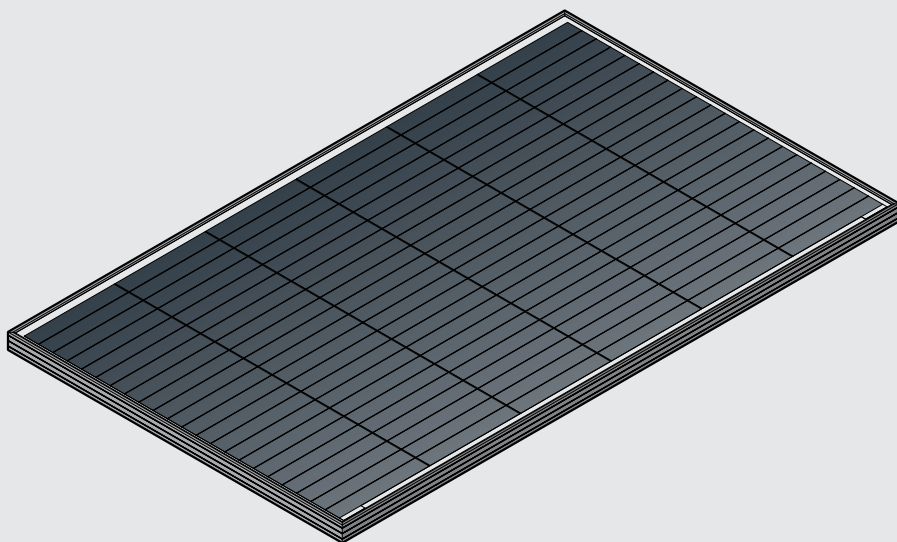

WARNINGS & SAFETY INSTRUCTIONS

SAVE THESE INSTRUCTIONS — This manual contains important safety instructions. Do not operate the system unless you have read and understood this manual. REDARC recommends that the Solar Panel referenced in this manual be installed by a suitably qualified person.

Disclaimer: REDARC accepts no liability for any injury, loss or property damage which may occur from the improper or unsafe installation or use of its products.

SAFETY MESSAGE CONVENTIONS

Safety messages in this manual include a signal word to indicate the level of the hazard as follows:

▲ WARNING: Indicates a potentially hazardous situation which could result in death or serious injury to the operator or to bystanders.

▲ CAUTION: Indicates a potentially hazardous situation which may result in moderate or minor injury to the operator or to bystanders.

NOTICE: Indicates a situation that may cause equipment damage.

▲ WARNING

- 1. RISK OF EXPLOSIVE GASES:** Working in vicinity of a Lead-Acid battery is dangerous. Batteries generate explosive gases during normal operation. For this reason, it is of utmost importance that you follow the instructions when installing and using the Solar Panel.
- 2. RISK OF DAMAGE AND INJURY FROM IMPROPERLY SECURED PANELS:** Solar Panels mounted to all types of vehicles, including but not limited to, 4x4 vehicles, RVs, caravans, etc. are subject to high wind and vibration forces when driving. Fixed Solar Panels must be securely attached to the vehicle in accordance with all local and national safety standards.

▲ CAUTION

1. Do NOT connect the Solar Panel directly to a Battery. A Solar Regulator must be used between the Solar Panel and the Battery.
2. This appliance is not intended for use by persons (including children) with reduced physical, sensory or mental capabilities, or lack of experience and knowledge, unless they are supervised or have been instructed on how to use the appliance by a person responsible for their safety. Children should be supervised to ensure that they do not play with the appliance.
3. Only use the Solar Panel for charging Lead Acid, Gel, Calcium content, AGM or Lithium Iron Phosphate batteries using a Solar Regulator suitable for the Battery's chemistry.
4. The Battery should be mounted in a well ventilated area, as far as possible from any ignition sources. NEVER smoke or allow a spark or flame in the vicinity of battery or engine. This may cause the battery to explode.

5. An unconnected Panel exposed to light may generate voltages up to its rated open-circuit voltage at the connectors. Ensure the solar cells are not exposed to light when making electrical connections to the Panel to reduce the chance of an electrical spark.

PERSONAL SAFETY PRECAUTIONS: To assist with the safe operation and use of the Solar Panel when connected (via a Regulator) to the battery:

1. Wear complete eye protection and clothing protection. Avoid touching eyes while working near a battery.
2. If battery acid contacts your skin or clothing, remove the affected clothing and wash the affected area of your skin immediately with soap and water. If battery acid enters your eye, immediately flood the eye with running cold water for at least 10 minutes and seek medical assistance immediately.



NOTICE

1. The Solar Panel will achieve best results when proper battery maintenance is regularly performed. This includes but is not limited to checking water and specific gravity levels of the battery.
2. Do not use mirrors or other devices to artificially concentrate sunlight on the Panel.
3. All Panels used in series, parallel, or series-parallel should be positioned to receive identical amounts of light to reduce risk of Panel damage.
4. Partially shaded or partially obscured Solar Panels will have reduced output, and can potentially damage the Solar Panel.

PRODUCT OVERVIEW

REDARC Monocrystalline Solar Panels are highly efficient with a robust design. A tempered glass coating combined with an anodized aluminium frame ensures that our Solar Panels will withstand harsh road and extreme weather conditions.

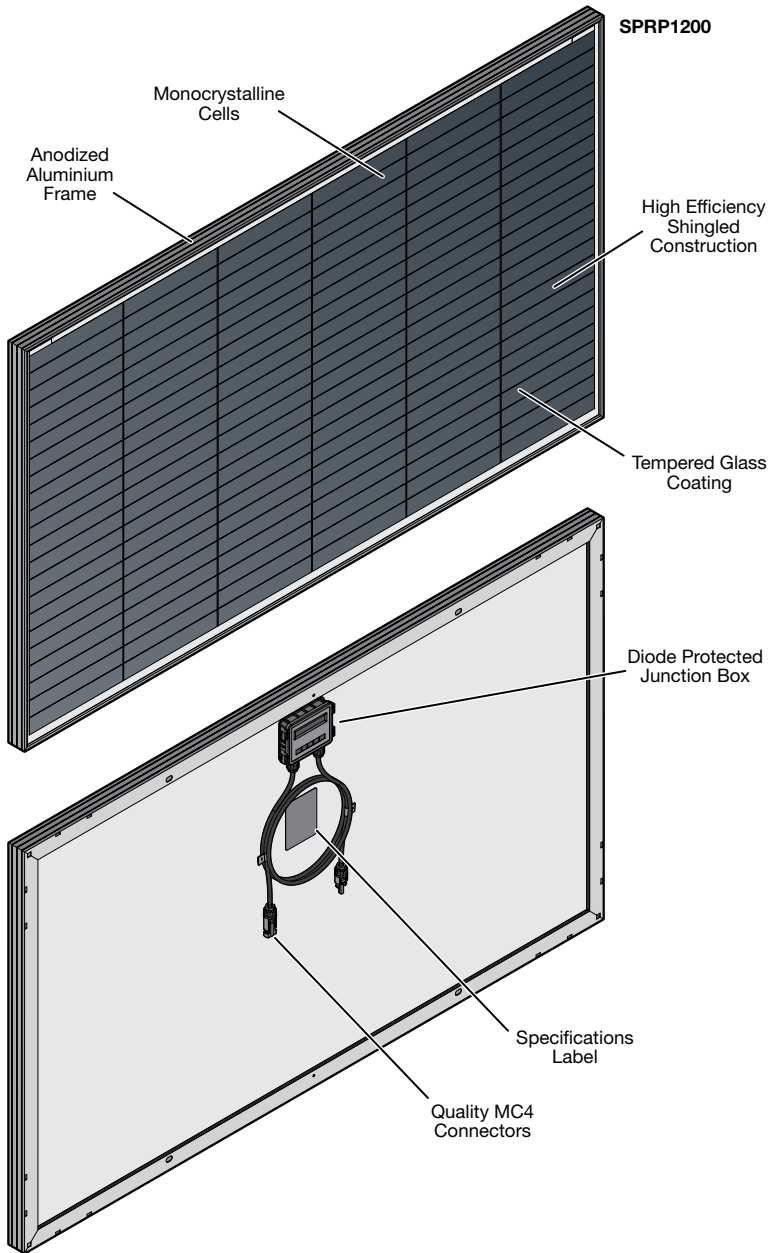

180 W SOLAR PANEL SPECIFICATIONS

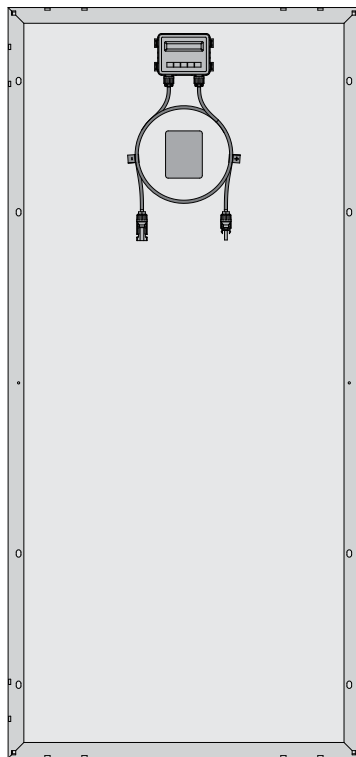
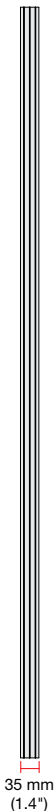
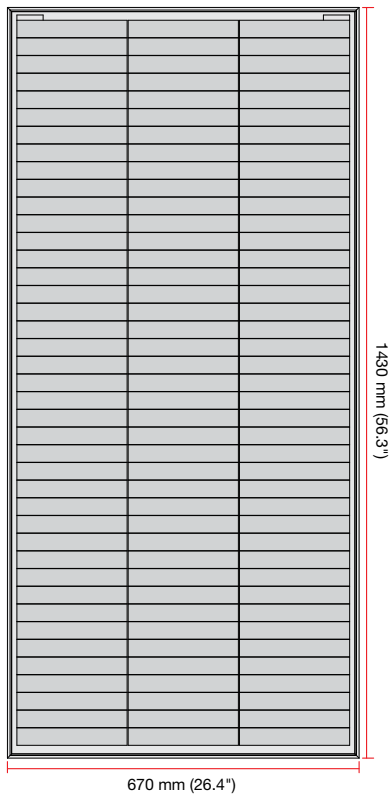

Product Number	SPRP1180
Maximum Power	180 W
Cell Type	Monocrystalline
Cable Length	900 mm (35.4")
Connector Type	MC4 Style Connector
Frame	Anodized Aluminium
Front Material	Tempered Glass
Maximum Power Voltage	23.4 V
Maximum Power Current	7.7 A
Open Circuit Voltage	27.6 V

Short Circuit Current	8.2 A
Maximum Power Tolerance	±3%
Operating Temperature	-40°C to +85°C (-40°F to +185°F)
Dimensions	1430 × 670 × 35 mm (56.3" × 26.4" × 1.4")
Weight	10.4 kg (22.9 lbs)
Compliance	CE, UKCA, RCM
Standard Test Conditions	AM1.5 1000 W/m ² 25°C (77°F)

200 W SOLAR PANEL SPECIFICATIONS

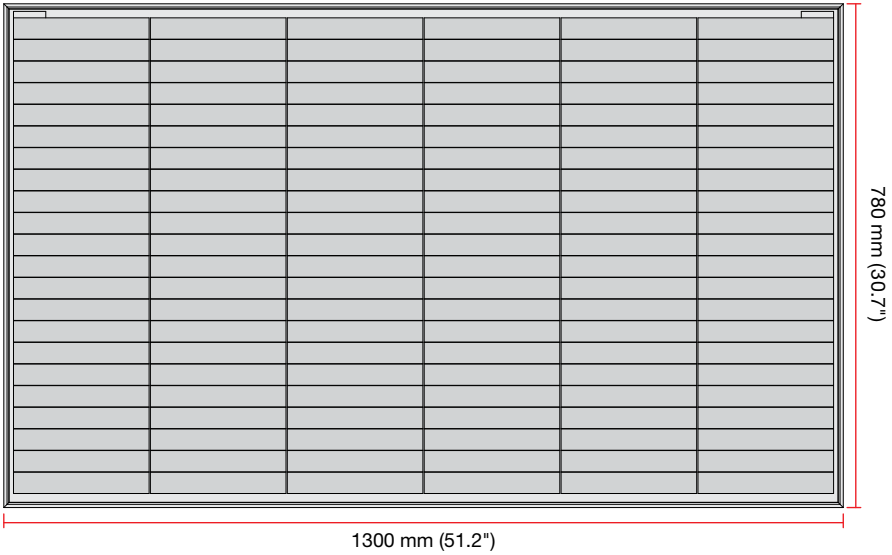

Product Number	SPRP1200
Maximum Power	200W
Cell Type	Monocrystalline
Cable Length	900 mm (35.4")
Connector Type	MC4 Style Connector
Frame	Anodized Aluminium
Front Material	Tempered Glass
Maximum Power Voltage	25.0V
Maximum Power Current	8.0A
Open Circuit Voltage	29.5V

Short Circuit Current	8.5A
Maximum Power Tolerance	±3%
Operating Temperature	-40°C to +85°C (-40°F to +185°F)
Dimensions	1300 × 780 × 35 mm (51.2" × 30.7" × 1.4")
Weight	10.6 kg (23.4 lbs)
Compliance	CE, UKCA, RCM
Standard Test Conditions	AM1.5 1000 W/m ² 25°C (77°F)

SOLAR OPTIMISATION

ANGLE TO THE SUN

REDARC Solar Panels will perform at their peak when the monocrystalline cells are angled directly towards the sun (this is not always achievable). REDARC recommends having the Solar Panel/s angled between 20° and 40° from the ground to ensure the best total output from your Panel across the course of the day, no matter what season.

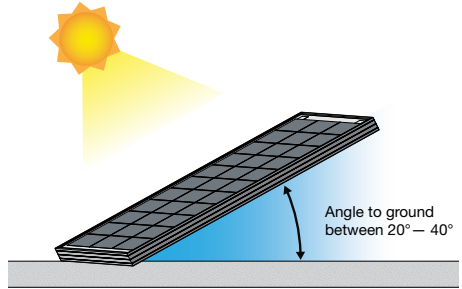

In the **southern hemisphere**, the sun is always in the northern half of the sky, facing your Panel **NORTH** ensures the best angle to the sun for a Solar Panel across the course of the day.

In the **northern hemisphere**, the sun is always in the southern half of the sky, facing your Panel **SOUTH** ensures the best angle to the sun for a Solar Panel across the course of the day.

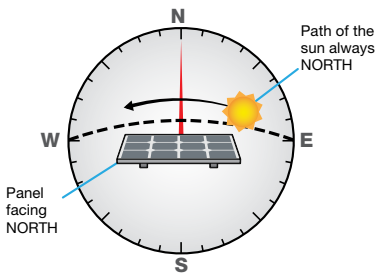

Southern Hemisphere

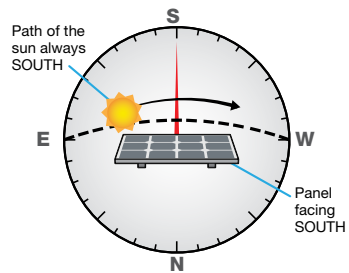

Northern Hemisphere

BE AWARE OF SHADING

Care must be taken to avoid the possibility of shading in the final installation position.

Be aware of shading that can occur from having roof mounted accessories on your RV, caravan or motor home. Shaded sections on your Solar Panels will significantly reduce your Solar Panels performance and may lead to Panel damage.

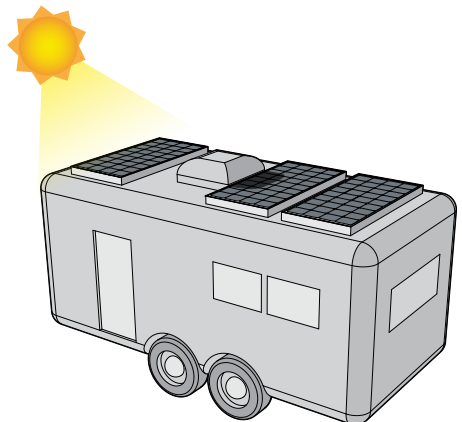

⚠ CAUTION: During the installation process, ensure that the Panels are covered with an opaque material to prevent potentially dangerous voltages from inadvertently being generated.

INSTALLATION – MOUNTING

⚠ WARNING: RISK OF DAMAGE AND INJURY FROM IMPROPERLY SECURED PANELS: Solar Panels mounted to all types of vehicles, including but not limited to, 4x4 vehicles, RVs, caravans, etc. are subject to high wind and vibration forces when driving. Solar Panels must be securely attached to the vehicle in accordance with all local and national safety standards.

SOLAR MOUNTING BRACKETS

The REDARC Solar Mounting Brackets are designed to mount a single Solar Panel to the roof of your vehicle. Refer to the Mounting Brackets supplied Instruction Manual for installation instructions.

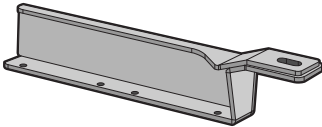

SPMB0001

Suited to mount a Solar Panel to sports style crossbars including both Rhino-Rack Vortex crossbars and the Rhino-Rack heavy duty crossbars.

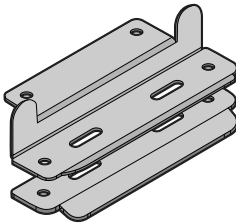

SPMB0002

Suited to mount a Solar Panel to an ARB Base Rack and Rhino-Rack Steel Mesh Platform systems.

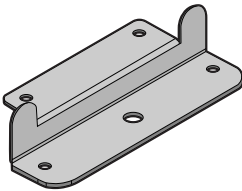

SPMB0003

Suited to mount a Solar Panel to Rhino-Rack Pioneer Platform crossbars.

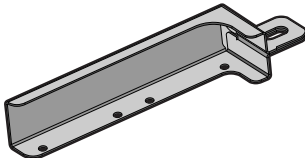

SPMB0004

Suited to mount a Solar Panel to Unistrut Series Channel systems and EzyStrut Plain Channel systems.

ABS PLASTIC MOUNTS

ABS Plastic Corner, Side and Spoiler Mounts (SMI9001, SMI9002 and SMI9007) are designed to mount single or multiple Panels to your RV or Caravan roof without needing to drill directly on your RV or Caravan roof. Refer to the diagram below to determine which ABS Mount is suitable for your setup and the ABS Plastic Mount Instruction Manual for installation instructions.

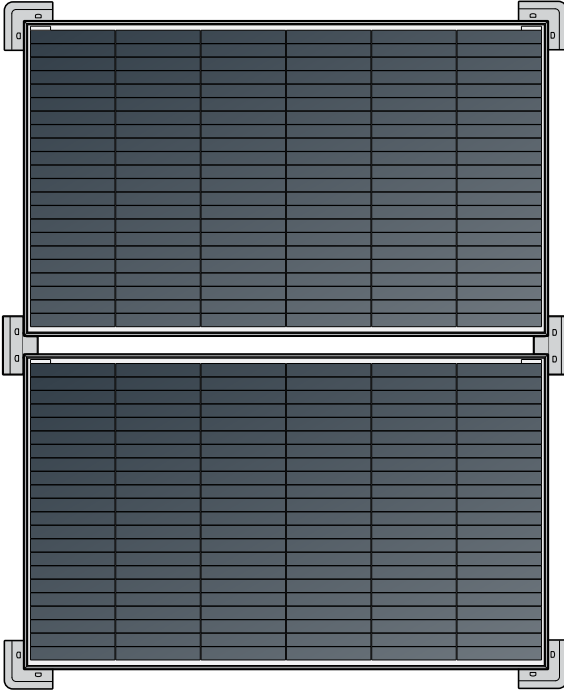

SMI9001
4 × ABS Plastic
Corner Mounts

145 mm
(5.7")

Suitable for all
Solar Panels.

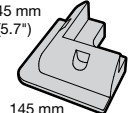

145 mm
(5.7")

SMI9002

2 × ABS Plastic Side Mounts for
mounting multiple panels. Suitable
for all Solar Panels.

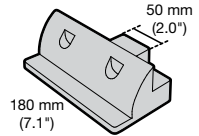

180 mm
(7.1")

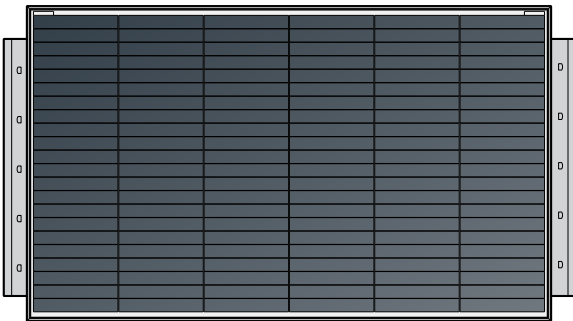

SMI9007
2 × ABS Plastic
Spoiler Mounts

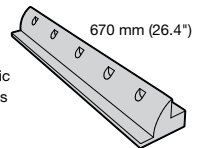

670 mm (26.4")

INSTALLATION – WIRING

WIRING PRECAUTIONS

- Ensure that all connections are made using REDARC recommended connectors and cables or other suitably rated connectors and cables.
- Ensure that the total system current does not exceed the maximum current rating for either of the cables or connectors that are subject to the total current of the system (refer to the specifications of your Solar Panel for more information).
- Ensure that appropriate fuses are used when connecting to a battery.
- Ensure that all MC4 connections are crimped with the correct MC4 crimping tool. Contact REDARC for more information on purchasing this tool.
- All cable entries into the vehicle must be suitably sealed, REDARC Single Cable Gland (SMC0001) is recommended for routing a single cable into your vehicle, caravan or RV.
- REDARC recommends when using a regulator that it is installed as close as possible to the auxiliary battery/s.
- Ensure the cable length from the Solar Panel to the regulator does not exceed 10m (32'8").
- If your regulator has a dedicated solar input (negative) terminal ensure that the negative ground from your solar panel is only connected here and is not connected to chassis ground.

MAINTENANCE

- Periodically check that the Solar Panel is safely secured in its mounted position. Parts used to mount the Solar Panel may become loose as a result from repeated vibration, particularly if the vehicle has been travelling on uneven/corrugated road surfaces.
- DO NOT use a high pressure hose to clean the Solar Panel. Use a damp cloth to clean Panel surfaces.
- DO NOT use any chemical cleaning agents as it may damage the solar cell surface and degrade performance.

SYSTEM WIRING – ANDERSON™ TO BATTERY CLIP CABLE

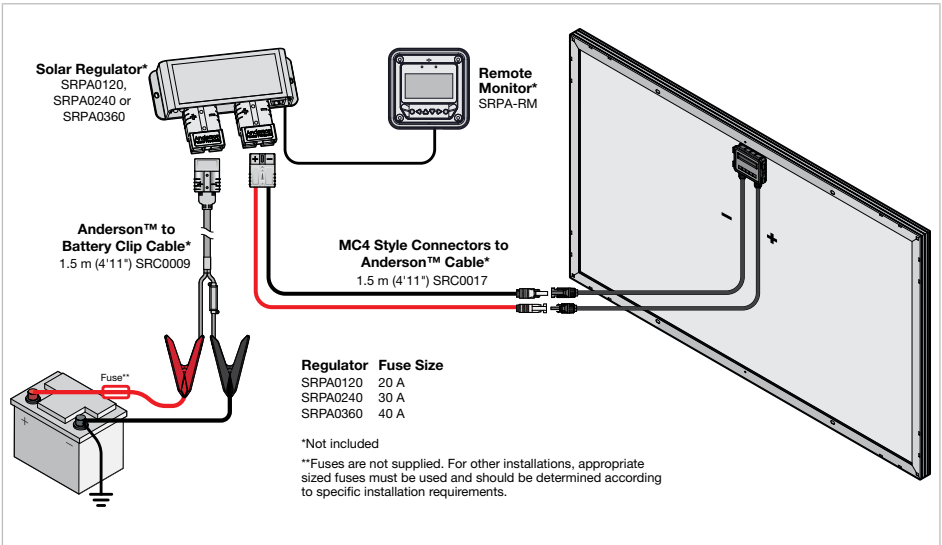

SYSTEM WIRING – ANDERSON™ TO BATTERY EYELET TERMINAL CABLE

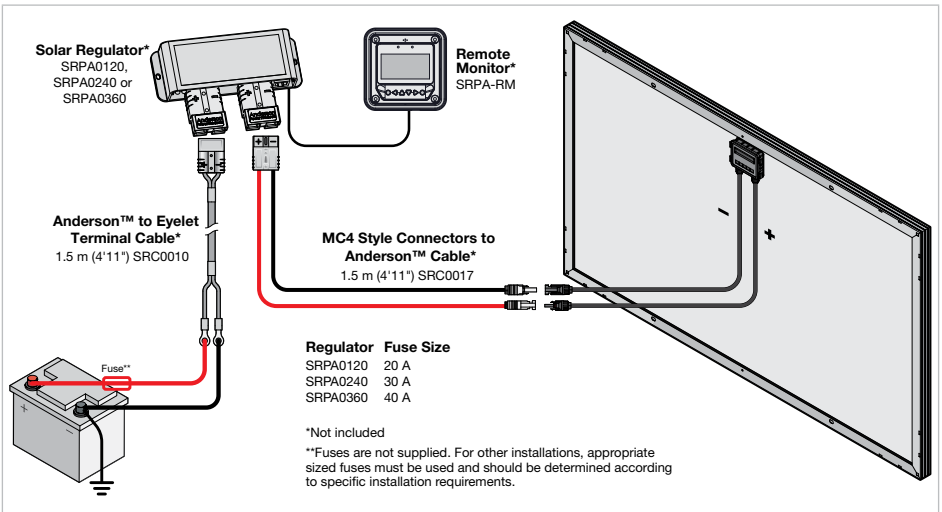

SERIES AND PARALLEL CONNECTIONS

Solar arrays can be connected in series or parallel as demonstrated below.

NOTICE:

- Ensure that the Regulator input is rated for the sum of the maximum open circuit voltage of each Panel connected in series.
- Ensure that the system components are rated for the sum of the short circuit currents of each Panel connected in parallel.
- Connecting two Panels that do not have identical ratings may cause damage to the Panels.
- Panels connected in parallel or series that are subjected to different levels of sunlight may be damaged.

SERIES CONNECTIONS

Connecting two identical Panels (of the same wattage) in series will multiply the system voltage by 2 and keep the output current at the same level. Series connections can be made by connecting the positive connector of one Panel to the negative of the next.

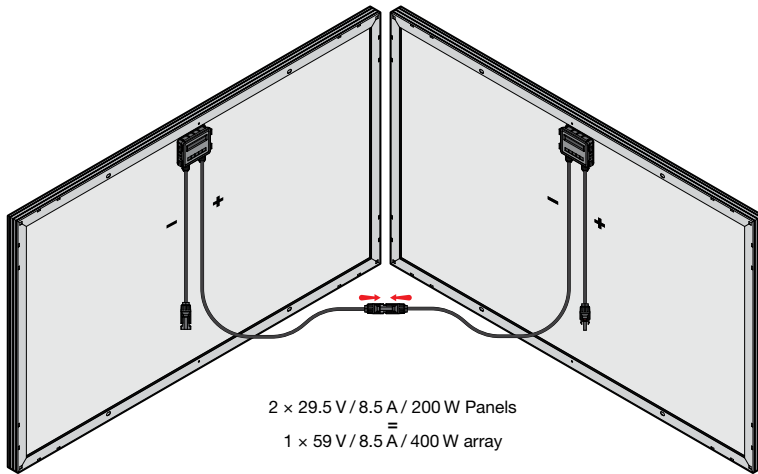

PARALLEL CONNECTIONS

Connecting two identical Panels (of the same wattage) in parallel will multiply the total output current by 2 and keep the system voltage at the same level. Parallel connections can be made using the REDARC MC4 Connector Y-Adaptor cable (SRC0006).

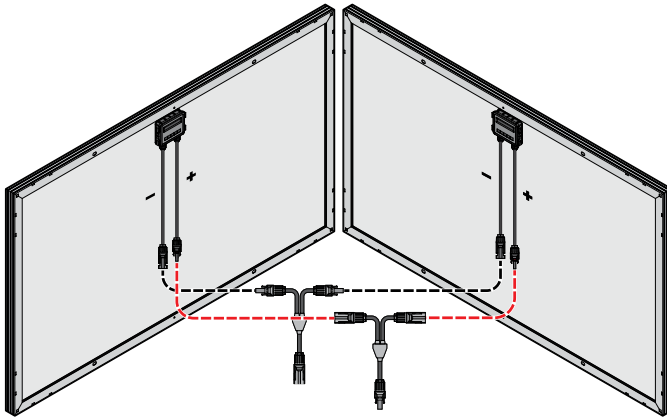

$$2 \times 29.5 \text{ V} / 8.5 \text{ A} / 200 \text{ W Panels} = 1 \times 29.5 \text{ V} / 17 \text{ A} / 400 \text{ W array}$$

WIRING PANELS IN PARALLEL WITH A BCDC

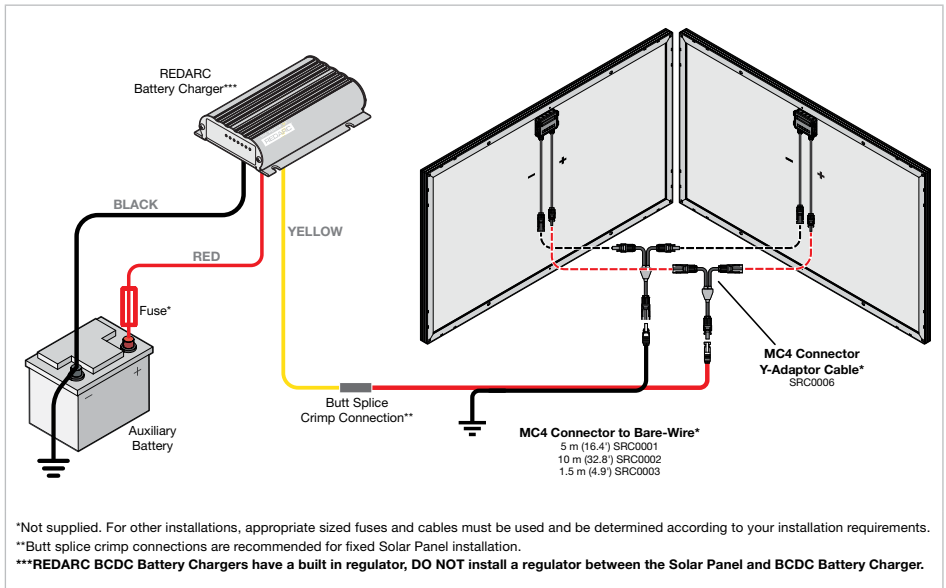

WARRANTY

LIMITED WARRANTY

For full warranty terms and conditions, visit the Warranty page of the REDARC website:
www.redarcelectronics.com/warranty

Australia, New Zealand, UK & Europe

REDARC Electronics Pty Ltd
23 Brodie Road (North),
Lonsdale SA 5160
Australia

Australia +61 8 8322 4848
New Zealand +64 9 222 1024
UK & Europe +44 (0)20 3930 8109

North America

REDARC Corporation
c/o Shallco, Inc.
308 Component Dr.
Smithfield, NC 27577
USA

USA +1 (704) 247 5150
Canada +1 (604) 260 5512
Mexico +52 (558) 526 2898

IMPORTER CONTACT INFORMATION

UK

Ozparts UK Ltd
1 Prospect Place
Pride Park
DE24 8HG, Derby
UK

Europe

Ozparts Pl sp. z o. o.
ul. Slowackiego 32/5
87-100 Torun
Poland



Design, product configuration and technical specifications are subject to change without notice. | Copyright © REDARC Electronics Pty Ltd. All rights reserved. | REDARC® and THE POWER OF REDARC® are trademarks of REDARC Electronics Pty Ltd.

REDARC Electronics Pty Ltd | ABN 77 136 785 092
REDARC Electronics Pty Ltd, 23 Brodie Road (North), Lonsdale SA 5160, Australia

Tech Support

1300 REDARC (1300-733-272)

Australia

+61 8 8322 4848

New Zealand

+64 9 222 1024

UK & Europe

+44 (0)20 3930 8109

USA

+1 (704) 247-5150

Canada

+1 (604) 260-5512

Mexico

+52 (558) 526-2898

redarcelectronics.com

THE POWER OF

